

Doo Yong Electricity Multiple Socket Outlet considers safety, environment and even convenience

두용전기 멀티콘센트는 첫째 안전, 둘째 환경, 셋째 편리성까지 생각했습니다



Energy saving multiple socket outlet & multi-purpose multiple socket outlet series

두용전기 멀티콘센트 시리즈

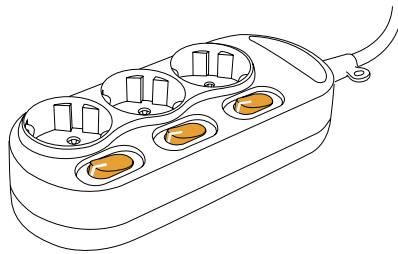

Electric shock protection patent



Environment application patent



one-touch plug patent

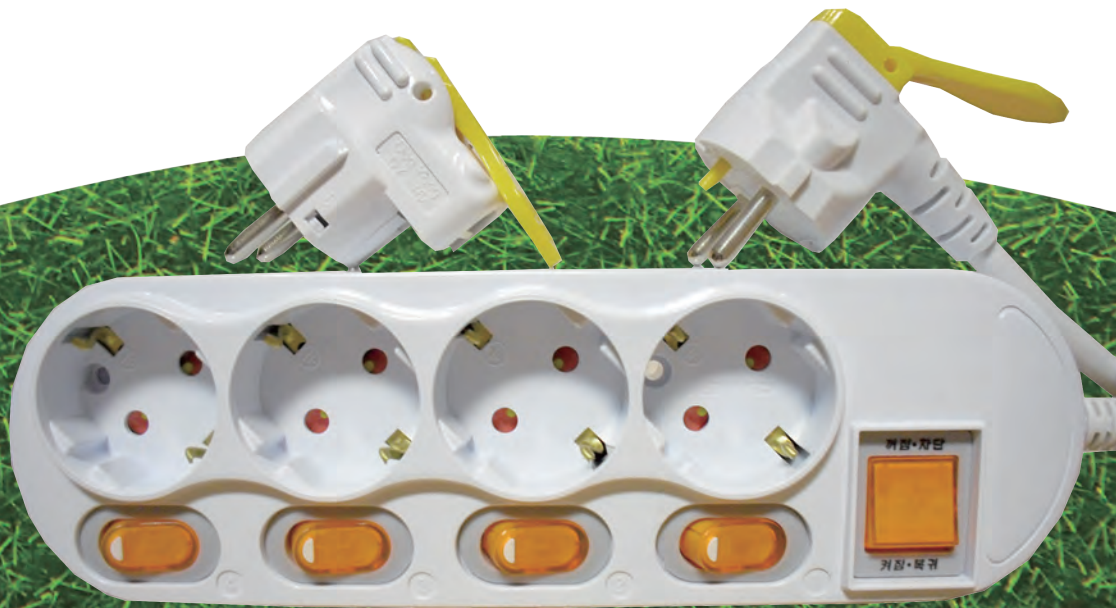

www.vichion.com



Doo Yong Electricity



두용전기는 멀티콘센트 전문생산 업체입니다

Dooyong Electricity is specialized in manufacturing multiple socket outlets.

- 두용전기 멀티콘센트 3 가지 특허 및 특징(기본 멀티콘센트는 3가지 특허적용. 주문시 별도제작)
Doo Yong Electricity 3 patents & features(basic multiple socket outlets are applied with 3 patents. Customized products available)
- 대한민국 조달청 우수제품명(안전형 비납땜 영구접속형 멀티콘센트) 3가지 특허 적용하여 현재 납품중
Korea Public Procurement Service designated excellent product(Safe non-soldered permanent connection type multiple socket outlet) 3 patents-applied and being supplied

1 특허10-1164431호, 발명명칭: 멀티탭의 단자고정구 Patent10-1164431, Title of the invention: Fixation device of multiple socket outlets

- 친환경 비납땜 제조 방식으로 화재 및 감전사고 예방
- Eco-friendly non-soldered manufacturing for protecting fire and electric shock



〈 멀티탭의 단자 고정구(통전단자 연결방법) 〉
Fixation device of multiple socket outlets
(electric current flowing plug connection)

납으로 인한 토양중금속오염방지 및 작업자 환경, 건강 위하여 납땜을 이용한 통전극 단자 연결방법을 대체용인 친환경적인 멀티탭의 단자고정구 기술 특허 Patent of Fixation device of multiple socket outlet, eco-friendly substitute for the past whole poles connection method using soldering in order for soil contamination protection from lead, the worker's health and environment

(멀티콘센트 제조규격서 IEC-60884-1에 의하면 통전극 단자는 납땜, 리벳, 틀고정 제조방식으로 규정)
(the multiple socket outlet manufacturing description IEC-60884-1 describes whole pole GND is manufactured by/with soldering/rivet/frame fixation)

2 특허 10-1237049호, 발명명칭: 전원 플러그 장치 Patent 10-1237049: Title of the Invention: power supply plug device

- 지렛대 원리를 이용하여 사용이 편리한 전원플러그
- Convenient plug device using the lever principle

전기플러그 뽑 때 지렛대 원리를 이용하여 플러그가 원터치형으로 뽑 수 있어 원터치플러그 적용을 하면 전기제품 제조시(사용시) 생산성증가, 감전사고예방.
As a plug can be pulled out simply by one-touch using the lever when pulling it out, the device can increase the productivity and protect from electric shock when manufacturing the electric product.

기존건축물 콘센트 파손방지, 노약자 또는 장애인이 전기플러그를 손가락 힘으로만 쉽게 빠지는 원터치 형 전기플러그 기술특허(원터치고장시사용할수있음)
Patent of one-touch type plug protecting the existing socket outlet breakdown and simply pulled out by finger operation even the elderly or the disabled(it can be used when one-touch is in trouble)



〈 원터치플러그 사용방법 〉
How to use one-touch plug

3 특허 10-1210584호, 발명명칭: 콘센트용 안전장치 Patent No. 10-1210584, Title of the invention: safety device for socket outlet

- 감전보호 2중 안전장치
- Dual safety device from electric shock

콘센트 구멍 충전부에 셔터장치를 2중 잠금 구조로, 적용하여 전기플러그 이외는 접촉이 안되는 콘센트 안전장치를 적용하므로써 젓가락을 콘센트 두 개의 구멍에 동시에 삽입하여도 충전부가 캐폐가 안되어 어린이 및 노약자의 감전보호예방이 월등한 기술특허
Patent exceptionally protecting children and the elderly from electric shock when the charging part is not open although two metal chopsticks are simultaneously inserted to holes as dual blocking structure is applied to avoid any contact except for electric plug



〈 젓가락 2개를 동시에 삽입하여도 감전예방 〉
To prevent electric shock be inserted chopsticks two at the same time

■ 인증서 / Certificate of Performance

- 대한민국 중소기업청(성능인증서) 및 조달청 (우수제품 지정증서)

Small and Medium Business Administration(Certificate of Performance) & Public Procurement Service (Certificate of Registration of Excellent Product)

- 성능인증명칭(비납땜 틀고정 영구 접속형 멀티콘센트)

Title of Certificate of Performance(Non-soldering frame fixation connection type multiple socket outlet)

- 우수제품 지정증서 명칭(비납땜 영구접속형 멀티콘센트)

Title of Certificate of Registration of Excellent Product(Non-soldering permanent connection type multiple socket outlet)

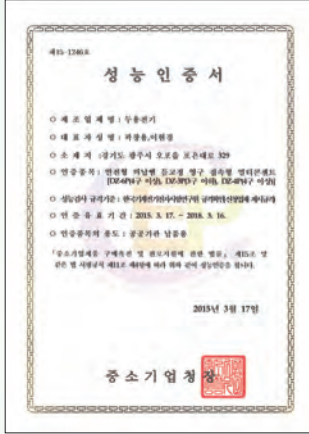

Certificate of Performance



Certificate of Registration of Excellent Product



Certificate of Registration of Excellent Product

■ 특허 및 전기용품 인증서 / KOREA Patent & Certificate of Electric Device



【전원플러그장치】
Power plug device

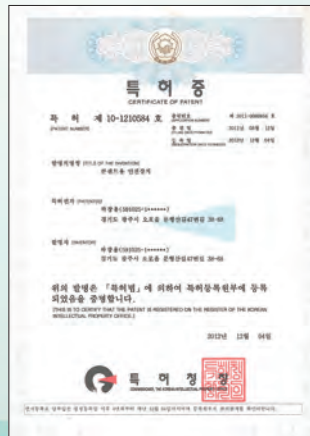

【콘센트용안전장치】
Safety device for socket outlet

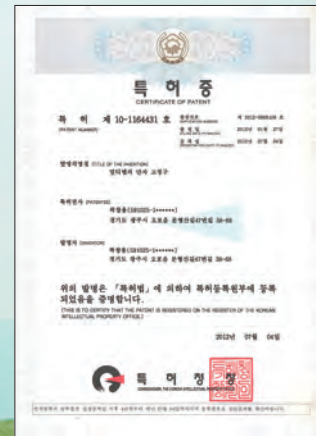

【멀티탭의 단자 고정구】
Fixation device of multiple socket outlet



【전기플러그】
Power plug device



【멀티탭의 접지단자구조】
Terminal structure of plug and multiple socket outlet



【전기용품 안전인증서】
Electrical Appliance Safety Certificate

- 제조사양서 / Manufacturing description

• Plug type : 멀티콘센트 주문에 따라 제조(manufacturing by the order of multiple socket outlet)

- Rating : AC 250V / 16A
- Material : PC / ABS / PBT / POM
- Cord Length : 1.5m, 3m, 5m
- 제원 : 도면 참조(refer to drawings)
- 특징(Features) :



- 4,5,6구 멀티콘센트는 과부하 사용시 자동 차단 및 수동 복귀형으로 2극 스위치를 적용, 스위치 OFF시 대기전력 100% 차단
- 4/5/6 multiple socket outlets can be automatically shut down and manually returned by using 2-pole switch and the standby power can be shut off 100% if the switch is off
- 콘센트 별로 개별스위치를 적용하여 개별스위치 OFF시 에너지 절약
- Energy saving when each switch is off by applying independent switch for each socket
- 개별스위치는 단순 기능성 스위치(과부하사용시 자동 차단 기능은 제외)
- Individual switch is simple functional switch(automatic shutoff function is exceptional when overload is used)
- 2구,3구 멀티콘센트는 과부하자동차단 기능 없음(과부하 차단 기능은 주문제작)
- 2/3 multiple socket outlets do not have automatic overload shutoff function(overload shutoff function is custom-manufactured)

- 에너지 절약형 멀티콘센트 / Type of product

■ 개별 절전 6구 멀티콘센트 / Power saving 6 sockets-outlet

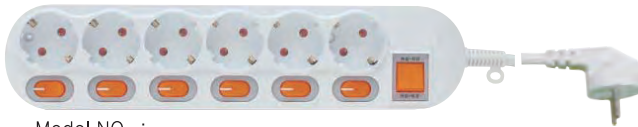

• Model NO. :
• Model NO. : DZ-6P(1.5m), DZ-6P3(3m), DZ-6P5(5m)

■ 개별 절전 5구 멀티콘센트 / Power saving 5 sockets-outlet



• Model NO. : DZ-5P1(1.5m), DZ-5P3(3m), DZ-5P5(5m)

■ 개별 절전 4구 멀티콘센트 / Power saving 4 sockets-outlet



• Model NO. : DZ-4P1(1.5m), DZ-4P3(3m), DZ-4P5(5m)

■ 개별 절전 3구 멀티콘센트 / Power saving 3 sockets-outlet



• Model NO. : DZ-3P(1.5m), DZ-3P3(3m), DZ-3P5(5m)

■ 개별 절전 2구 멀티콘센트 / Power saving 2 sockets-outlet



• Model NO. : DZ-2P1(1.5m), DZ-2P3(3m), DZ-2P5(5m)

[에너지절약 멀티콘센트 내부 조립 형상]
(Energy saving multiple socket outlet's inside assembling shape)



- 환경과 작업자의 건강을 위한 무납땜 「멀티탭 단자 고정구 특허」를 적용한 제조 방식(2구~6구 동일)
- Non-soldered manufacturing method (patented fixation device of multiple socket) for the environment and worker's health (same as 2-6 multiple types)

- 제조사양서 / Manufacturing description

• Plug type : 멀티콘센트 주문에 따라 제조(manufacturing by the order of multiple socket outlet)

- Rating : AC 250V / 16A
- Materials: PC / ABS / PBT / POM
- Cord Length : 1.5m, 3m, 5m
- 제원 : 도면 참조(refer to drawings)
- 특징(Features) :



- 4,5,6구 멀티콘센트는 과부하 사용시 자동 차단 및 수동복귀형으로 2극 스위치를 적용, 스위치 OFF시 대기전력 100% 차단
- 4/5/6 multiple socket outlets can be automatically shut down and manually returned by using 2-pole switch and the standby power can be shut off 100% if the switch is off
- 2구, 3구 멀티콘센트는 과부하자동차단 기능없음(과부하차단기능은 주문제작)
- 2/3 multiple socket outlets do not have automatic overload shutoff function(overload shutoff function is custom-manufactured)

- 다목적 멀티콘센트 / Type of product

■ 다목적 6구 멀티콘센트 / multi-purpose multiple 6 socket - outlet



• Model NO. : DZ-6PA(1.5m), DZ-6PB(3m), DZ-6PC(5m)

■ 다목적 5구 멀티콘센트 / multi-purpose multiple 5 socket - outlet



• Model NO. : DZ-5PA(1.5m), DZ-5PB(3m), DZ-5PC(5m)

■ 다목적 4구 멀티콘센트 / multi-purpose multiple 4 socket - outlet

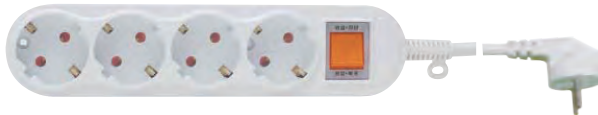

• Model NO. : DZ-4P(1.5m), DZ-4PB(3m), DZ-4PC(5m)

■ 다목적 3구 멀티콘센트 / multi-purpose multiple 3 socket - outlet



• Model NO. : DY-3PA(1.5m, 3m, 5m)

■ 다목적 2구 멀티콘센트 / multi-purpose multiple 2 socket - outlet



• Model NO. : DY-2PA(1.5m, 3m, 5m)

[멀티콘센트 내부 조립 형상]
(Multi-purpose multiple socket outlet's inside assembling shape)



- 환경과 작업자의 건강을 위한 무납땜 『멀티탭 단자 고정구 특허』를 적용한 제조 방식(2~3구 제외)
- Non-soldered manufacturing method (patented fixation device of multiple socket) for the environment and worker's health (same as 4-6 multiple types) Except for 2-way and 3-way product)

Wiring Diagram

Energy-Saving Multi-Outlet Wiring Diagram

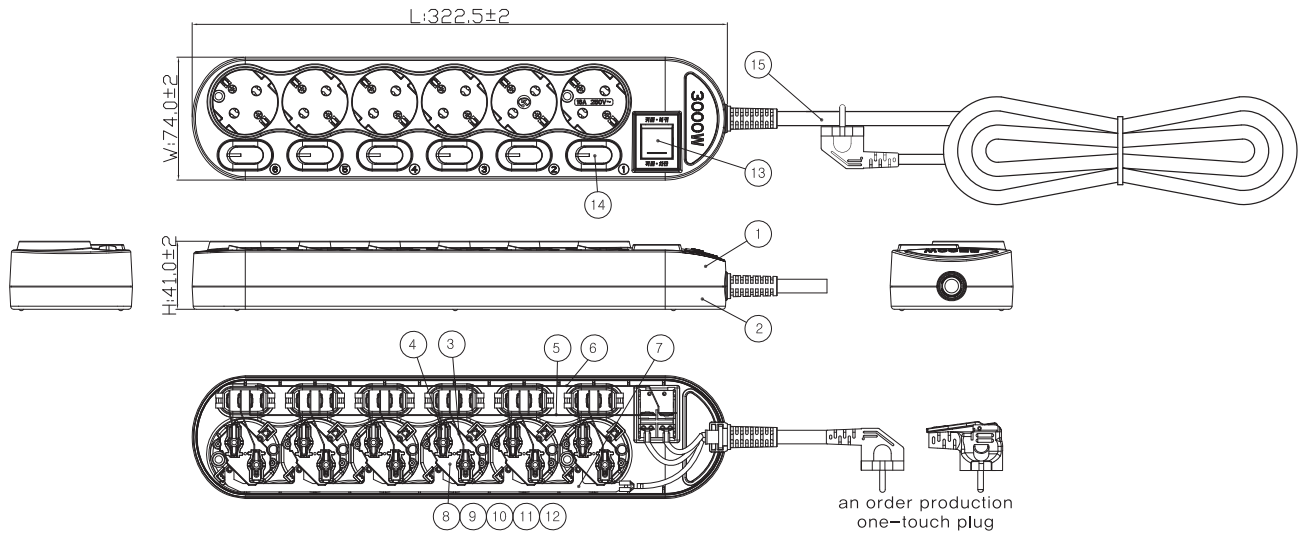

No.	Title	Material	Specification	Q1	Q2	Q3	Q4	Q5	Q6	Q7	Q8	Q9	Q10	Q11	Q12	Q13	Q14	Q15	Remarks
15	AC POWER CORD		16A 250VAC	1	1	1	1	1	1	1	1	1	1	1	1	1	1	1	KS, VDE, IEC60884-1 Cord Length: 1.5m, 3m, 5m
14	SWITCH ROCKER	YSR-2(21A)	16A 250VAC	6	5	4	3	2											Double Pole Rocker Switch TUV, KC, UL
13	SWITCH BIMETAL	YST-01	16A 250VAC	1	1	1	1												Double Pole Rocker Switch Circuit Protector TUV, KC, UL
12	SPRING	PW		6	5	4	3	2											
11	TERMINAL GROUND	C288-1(2H) 0.5		6	5	4	3	2											
10	LOCKER	P0TILL94V-0		6	5	4	3	2											COLOR : YELLOW
9	SAFETY PIN	P0TILL94V-0		6	5	4	3	2											COLOR : PINK
8	COVER SAFETY PIN	P0TILL94V-0		6	5	4	3	2											COLOR : WHITE, Black
7	BRIDGE GROUND	C288-H 0.5		1	1	1	1	1											
6	BRIDGE TERMINAL(L)	C288-H 0.5		1	1	1	1	1											
5	BRIDGE TERMINAL(R)	C288-H 0.5		1	1	1	1	1											
4	KNIFE ADAPTER(R)	C288-H 0.5		6	5	4	3	2											
3	KNIFE ADAPTER(L)	C288-H 0.5		6	5	4	3	2											
2	COVER BOTTOM	PC,ABS,UL94V-0		1	1	1	1	1											COLOR : WHITE
1	COVER TOP	PC,ABS,UL94V-0		1	1	1	1	1											COLOR : WHITE

Model	Size	Shape	Remarks	Relationship of approval, number
DZ-2P1	(L)138,5(W)74		2sockets outlet	KTC HH04008 -14016C
DZ-2P3/2P5	(H)41			
DZ-3P1	(L)180,5(W)74		3sockets outlet	KTC HH04008 -14016C
DZ-3P3/3P5	(H)41			
DZ-4P1	(L)238(W)74		4sockets outlet	KTC HH04008 -14016C
DZ-4P3/4P5	(H)41			
DZ-5P1	(L)280(W)74		5sockets outlet	KTC HH04008 -14016C
DZ-5P3/5P5	(H)41			
DZ-6P1	(L)322,5(W)74		6sockets outlet	KTC HH04008 -14016C
DZ-6P3/6P5	(H)41			

multi-purpose multiple socket - outlet Wiring Diagram

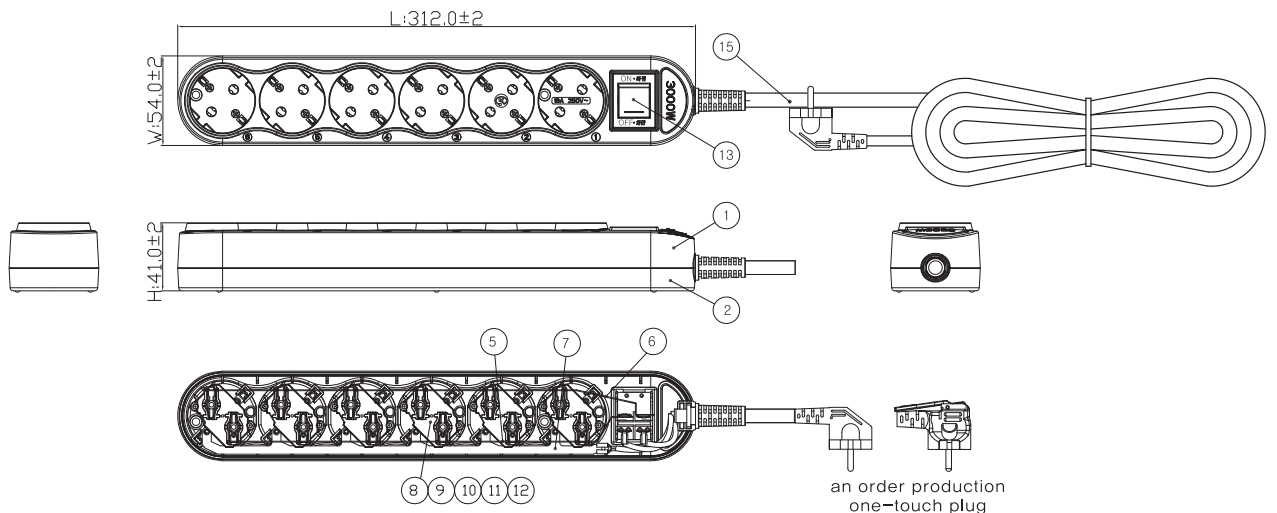

No.	Title	Material	Specification	Q1	Q2	Q3	Q4	Q5	Q6	Q7	Q8	Q9	Q10	Q11	Q12	Q13	Q14	Q15	Remarks
15	AC POWER CORD		16A 250VAC	1	1	1	1	1	1	1	1	1	1	1	1	1	1	1	KS, VDE, IEC60884-1 Cord Length: 1.5m, 3m, 5m
14	SWITCH ROCKER	YSR-2(21A)	16A 250VAC	0	0	0	0	0	0										Double Pole Rocker Switch TUV, KC, UL
13	SWITCH BIMETAL	YST-01	16A 250VAC	1	1	1	1												Double Pole Rocker Switch Circuit Protector TUV, UL
12	SPRING	PW		6	5	4	3	2											
11	TERMINAL GROUND	C288-1(2H) 0.5		6	5	4	3	2											
10	LOCKER	P0MILL94V-0		6	5	4	3	2											COLOR : YELLOW
9	SAFETY PIN	P0MILL94V-0		6	5	4	3	2											COLOR : PINK
8	COVER SAFETY PIN	P0TILL94V-0		6	5	4	3	2											COLOR : WHITE, Black
7	BRIDGE GROUND	C288-H 0.5		1	1	1	1	1											
6	BRIDGE TERMINAL(L)	C288-H 0.5		1	1	1	1	1											
5	BRIDGE TERMINAL(R)	C288-H 0.5		1	1	1	1	1											
4	KNIFE ADAPTER(R)	C288-H 0.5		0	0	0	0	0											
3	KNIFE ADAPTER(L)	C288-H 0.5		0	0	0	0	0											
2	COVER BOTTOM	PC,ABS,UL94V-0		1	1	1	1	1											COLOR : WHITE
1	COVER TOP	PC,ABS,UL94V-0		1	1	1	1	1											COLOR : WHITE

Model	Size	Shape	Remarks	Relationship of approval, number
DZ-2P1	(L)127(W)54		2sockets outlet	KTC HH04008 -14016C
DZ-2P3/2P5	(H)41			
DZ-3P1	(L)169(W)54		3sockets outlet	KTC HH04008 -14016C
DZ-3P3/3P5	(H)41			
DZ-4P1	(L)228(W)54		4sockets outlet	KTC HH04008 -14016C
DZ-4P3/4P5	(H)41			
DZ-5P1	(L)270(W)54		5sockets outlet	KTC HH04008 -14016C
DZ-5P3/5P5	(H)41			
DZ-6P1	(L)312(W)54		6sockets outlet	KTC HH04008 -14016C
DZ-6P3/6P5	(H)41			

*AC 코드, 원터치플러그, 개별 절전 6구 누전차단기 멀티콘센트 주문시 VDE 인증 및 국가별 인증 취득후 제작 납품
 *AC cord, One-touch plug, Individual switch 6-way earth leakage breaker Multiple socket outlet
 Upon an order, products are manufacture and delivered after acquiring VDE certificate and national certificates.

■ 오븐용 원터치플러그 코드
 One-touch plug type cord for oven



- 인증번호 / Safety certificate number : HH04008-13013/13012
- 주문자제조 / OEM-manufacturing
- Rating : AC 250V / 16A/10A
- Wire-Square : VCTF 1,5mm²/1,0mm² 3C
- 특징 / Features : 원터치형 플러그(One-touch plug type)

■ 무접지 원터치 코드
 Non GND one-touch cord



- 인증번호 / Safety certificate number : 안전인증 진행중
- 주문자제조 / OEM-manufacturing
- Rating : AC 250V / 16A/10A
- Wire-Square : VCTF 1,0mm²/0,75mm² 2C
- 특징 / Features : 원터치형 플러그(One-touch plug type)

■ 컴퓨터용 원터치형 플러그
 Computer one-touch type plug



- 인증번호 / Safety certificate number : HH04008-13013/13012
- 주문자제조 / OEM-manufacturing
- Rating : AC 250V / 16A/10A
- Wire-Square : VCTF 1,5mm²/1,0mm² 3C
- 특징 / Features : 원터치형 플러그(One-touch plug type)

■ 노출형 원터치 플러그
 Exposed one-touch plug



- 인증번호 / Safety certificate number : HH04008-13014
- 주문자제조 / OEM-manufacturing
- Rating : AC 250V / 16A/10A
- 특징 / Features : 원터치형 플러그(One-touch plug type)
 : 사용자 직접연결(personally built by a user)

■ 개별 절전 6구 누전차단 멀티콘센트
 Individual switch 6-way earth leakage breaker Multiple socket outlet



- 인증번호 / Safety certificate number : HH04008-8011
- 주문자제조 / OEM-manufacturing
- Rating : AC 250V / 16A/10A
- Materials : PC / ABS / PBT / POM
- 특징 / Features : - 코드없음, 과부하 및 누전시 자동차단, 개별절전, 전선고정구, 벽부착 나사홀
 - wall-fixation screw holes, 2-pole switch, Using without GND
 - 2극 스위치를 적용하여 SW OFF시 대기전력 100% 차단, 접지시설 없이 사용
 - cordless, automatic shutoff against overload and electric leakage, Individual power saving, electric wire fixation, 100% standby power saving by using
- 주의 / Notice : 개별스위치는 기능성 ON/OFF 과부하 및 누전시 는 차단 안됨
 individual switch cannot be protected from overload or electric leakage according to on/off operation

* Remove the cover of earth leakage circuit breaker before wiring work
 (전선연결시는 누전차단기 커버를 연후 전선연결)

● Korea Public Procurement Expo 2016



- 2016 코리아 나라장터 엑스포 전시, 두용전기 멀티콘센트 우수 조달물품 지정 (2015.7.3)



**Doo Yong Electricity
Company overview**

두용전기는 멀티콘센트 전문생산 업체입니다.

많은 사람들이 사용하는 멀티콘센트는 전기공급용 다목적 멀티 콘센트로 화재 및 감전 등 안전성이 매우 중요합니다. 두용전기는 국제규격 기준에 적합한 멀티콘센트를 연구 개발하여 여러 건의 특허를 보유하고 있으며, 우수한 성능을 인정받아 중소기업청으로부터 성능인증서를 취득하였습니다. 또한 두용전기 멀티콘센트는 대한민국 최초로 조달청 우수제품 물품으로 지정받아 2016년 현재 원자력발전소, 장애인 단체, 군부대, 학교, 기타 관공서에 납품하고 있으며 경기중소기업종합지원센터에서 주관하는 2017 프랑크푸르트 춘계 소비자 전시회에 참여 업체로 선정될 만큼 한국을 대표하는 멀티콘센트 회사입니다.

Doo Yong Electricity is specialized in manufacturing multiple socket outlets. Most people use multi-purpose multiple socket outlets, which more importantly should be protected from fire safely. Therefore, according to the international standards, Doo Yong Electricity researched and developed multiple socket outlets,

which were applied with originally developed patents and recognized for the performance from the Small & Medium Business Administration. With the certificate of performance, our multiple socket outlet products were first designated as the quality product from the Public Procurement Service. At 2016 currently, we supply the products to atomic power plants, associations of the handicapped, army units, schools and public offices. Also, the multiple socket-outlet products were selected in the 2017 Ambient the Show.

Doo Yong Electricity

- 329, Po Eun-daero Opo-eup, Gwangju-si Gyeonggi-do(12790), Rep of KOREA
- <http://www.vichion.com> · E-mail : shinjun51@daum.net
- TEL : 82-31-768-1957/1967
- FAX : 82-31-768-1977

두용전기

- 경기도 광주시 오포읍 포은대로 329(추자리 297-1)
- <http://www.vichion.com> · E-mail : shinjun51@daum.net
- TEL : 031) 768-1957/1967, 1566-5747 | FAX : 031) 768-1977